

Features

- N-channel dual-gate GaAs MES FET
- Depletion mode transistor for tuned small-signal applications up to 2 GHz, e. g. VHF, UHF, Sat-TV tuners
- Low noise
- High gain
- Low input capacitance

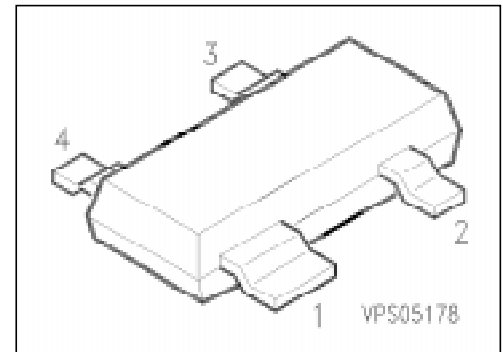

ESD: Electrostatic discharge sensitive device, observe handling precautions!

Type	Marking	Ordering Code (tape and reel)	Pin Configuration				Package ¹⁾
			1	2	3	4	
CF 739	MS	Q62702-F1215	S	D	G ₂	G ₁	SOT-143

Maximum Ratings

Parameter	Symbol	Values	Unit
Drain-source voltage	V_{DS}	10	V
Gate 1-source voltage	$-V_{G1S}$	6	
Gate 2-source voltage	$-V_{G2S}$	6	
Drain current	I_D	80	mA
Gate 1-source peak current	$+I_{G1SM}$	1	
Gate 2-source peak current	$+I_{G2SM}$	1	
Total power dissipation, $T_s \leq 66 \text{ }^\circ\text{C}^2)$	P_{tot}	240	mW
Channel temperature	T_{ch}	150	$^\circ\text{C}$
Storage temperature range	T_{stg}	- 55 ... + 150	

Thermal Resistance

Channel - soldering point ³⁾	R_{thchS}	≤ 350	K/W
---	-------------	------------	-----

¹⁾ For detailed information see chapter Package Outlines.

²⁾ Package mounted on alumina 15 mm × 16.7 mm × 0.7 mm.

³⁾ T_s is measured on the source lead at the soldering point to the pcb.

Electrical Characteristics

at $T_A = 25\text{ }^\circ\text{C}$, unless otherwise specified.

Parameter	Symbol	Values			Unit
		min.	typ.	max.	

DC Characteristics

Drain-source breakdown voltage $I_D = 100\text{ }\mu\text{A}$, $-V_{G1S} = -V_{G2S} = 4\text{ V}$	$V_{(BR)DS}$	10	–	–	V
Gate 1 leakage current $-V_{G1S} = 5\text{ V}$, $V_{G2S} = V_{DS} = 0$	$-I_{G1SS}$	–	–	20	μA
Gate 2 leakage current $-V_{G2S} = 5\text{ V}$, $V_{G1S} = V_{DS} = 0$	$-I_{G2SS}$	–	–	20	
Drain current $V_{G1S} = 0$, $V_{G2S} = 0$, $V_{DS} = 3\text{ V}$	I_{DSS}	6	–	60	mA
Gate 1-source pinch-off voltage $V_{G2S} = 0$, $V_{DS} = 5\text{ V}$, $I_D = 200\text{ }\mu\text{A}$	$-V_{G1S(P)}$	–	–	2.5	V
Gate 2-source pinch-off voltage $V_{G1S} = 0$, $V_{DS} = 5\text{ V}$, $I_D = 200\text{ }\mu\text{A}$	$-V_{G2S(P)}$	–	–	2.5	

AC Characteristics

Forward transconductance $V_{DS} = 5\text{ V}$, $V_{G2S} = 2\text{ V}$, $I_D = 10\text{ mA}$, $f = 1\text{ kHz}$	g_{fs}	–	25	–	mS
Gate 1 input capacitance $V_{G2S} = 2\text{ V}$, $V_{DS} = 5\text{ V}$, $I_D = 10\text{ mA}$, $f = 1\text{ MHz}$	C_{gfss}	–	0.95	–	pF
Output capacitance $V_{G2S} = 2\text{ V}$, $V_{DS} = 5\text{ V}$, $I_D = 10\text{ mA}$, $f = 1\text{ MHz}$	C_{dss}	–	0.5	–	
Noise figure $V_{G2S} = 2\text{ V}$, $V_{DS} = 5\text{ V}$, $I_D = 10\text{ mA}$, $f = 1.75\text{ GHz}$ $V_{G2S} = 2\text{ V}$, $V_{DS} = 5\text{ V}$, $I_D = 10\text{ mA}$, $f = 800\text{ MHz}$	F	–	1.8	–	dB
		–	1.1	–	
Power gain $V_{G2S} = 2\text{ V}$, $V_{DS} = 5\text{ V}$, $I_D = 10\text{ mA}$, $f = 1.75\text{ GHz}$ $V_{G2S} = 2\text{ V}$, $V_{DS} = 5\text{ V}$, $I_D = 10\text{ mA}$, $f = 800\text{ MHz}$	G_{ps}	–	17	–	
Control range $V_{G2S} = 2\text{ V} \dots -3\text{ V}$	ΔG_{psc}	–	50	–	

Total power dissipation $P_{tot} = f(T_A^*; T_S)$

*Package mounted on alumina

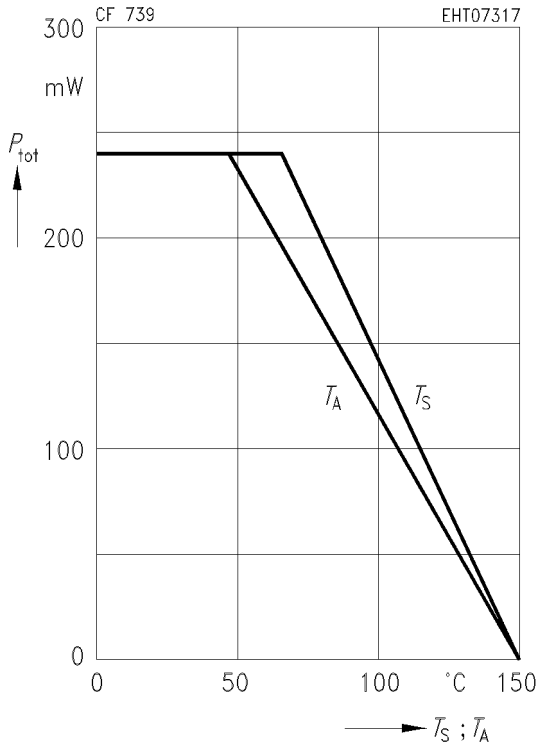

Output characteristics $I_D = f(V_{DS})$

$V_{G2S} = 2\text{ V}$

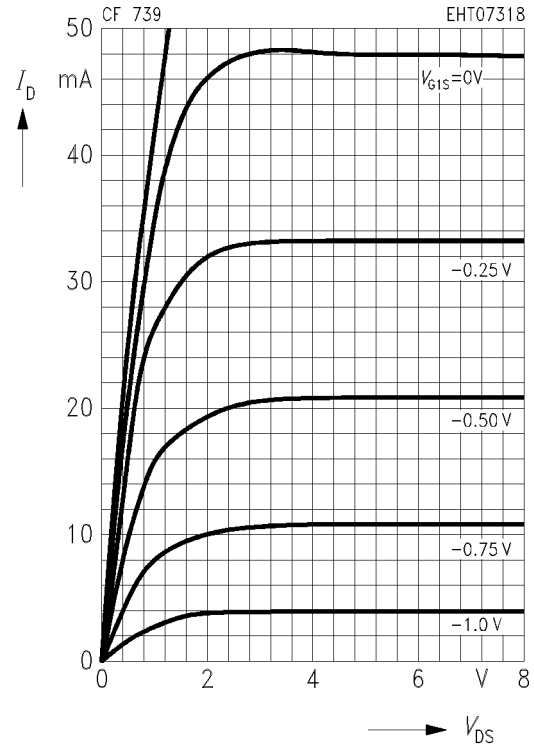

Gate 1 forward transconductance $g_{fs1} = f(V_{G1S})$

$V_{DS} = 5\text{ V}, f = 1\text{ kHz}$

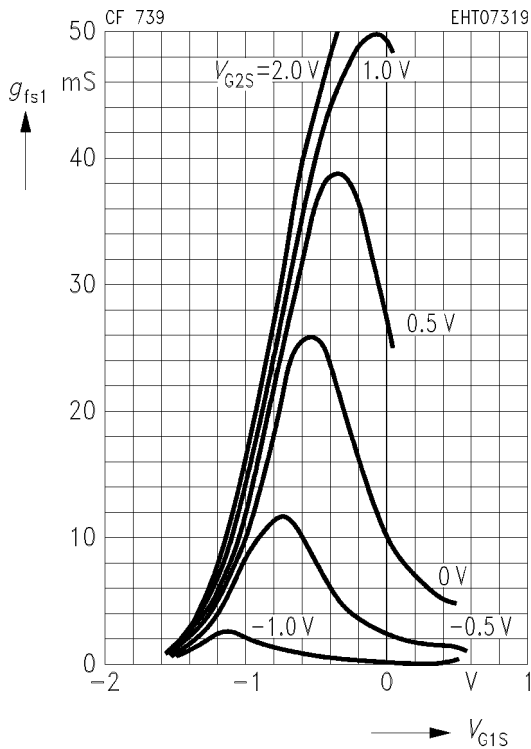

Gate 1 forward transconductance $g_{fs1} = f(V_{G2S})$

$V_{DS} = 5\text{ V}, f = 1\text{ kHz}$

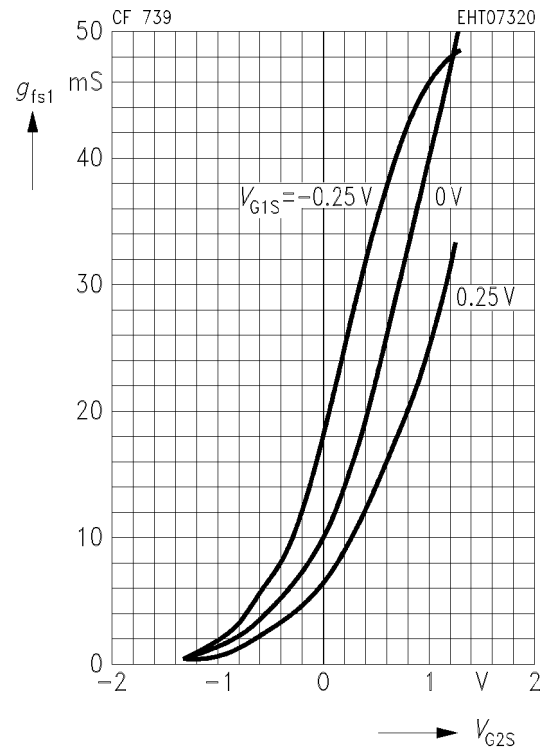

Drain current $I_D = f(V_{G1S})$

$V_{DS} = 5\text{ V}$

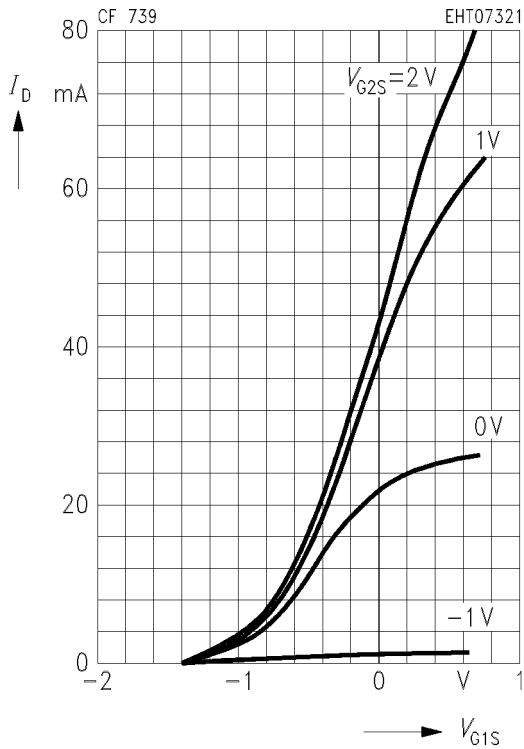

Drain current $I_D = f(V_{G2S})$

$V_{DS} = 5\text{ V}$

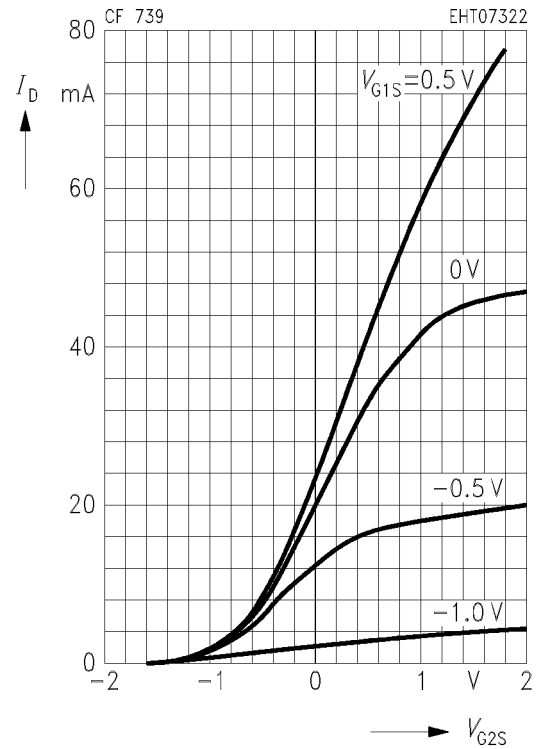

Gate 1 input transconductance

$C_{g1ss} = f(I_D)$

$V_{G2S} = 2\text{ V}$, $V_{DS} = 5\text{ V}$, $f = 0.1 - 1\text{ GHz}$

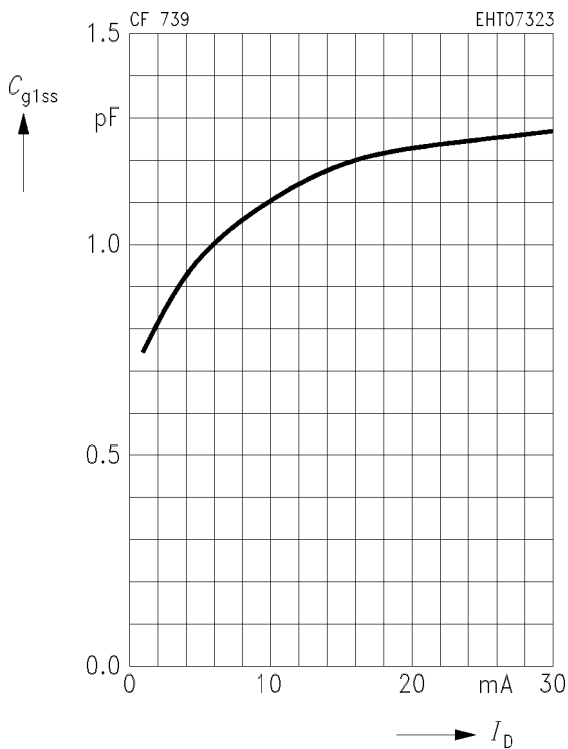

Output capacitance $C_{dss} = f(V_{DS})$

$V_{G2S} = 2\text{ V}$, $I_D = 10\text{ mA}$, $f = 0.1 - 1\text{ GHz}$

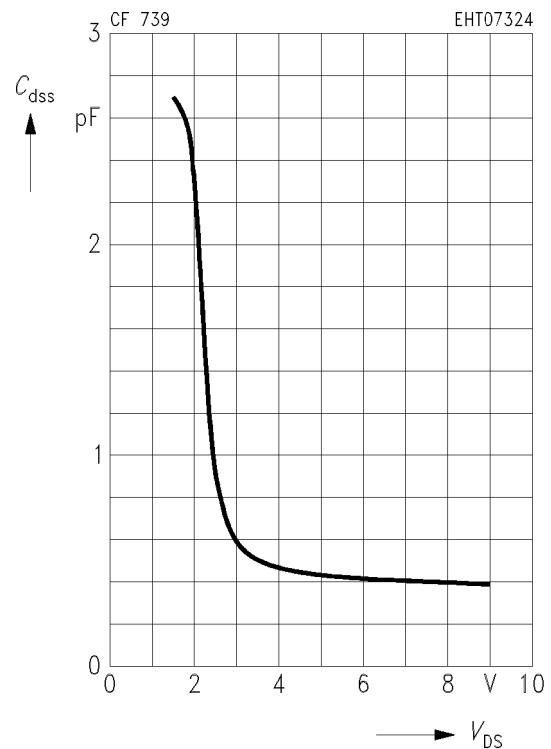

Common Source Admittance Parameters, G_2 RF grounded

Gate 1 input admittance y_{11s}

$V_{DS} = 5\text{ V}$, $V_{G2S} = 2\text{ V}$, $I_D = 10\text{ mA}$

Gate 1 forward transfer admittance y_{21s}

$V_{DS} = 5\text{ V}$, $V_{G2S} = 2\text{ V}$, $I_D = 10\text{ mA}$

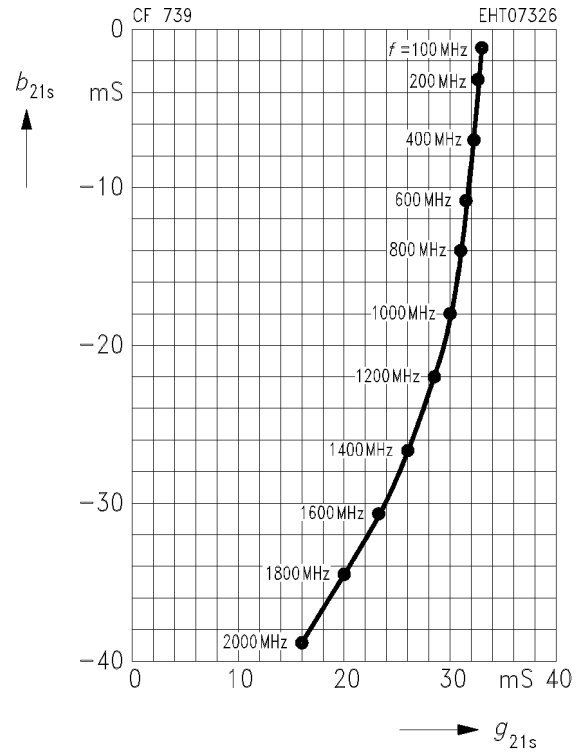
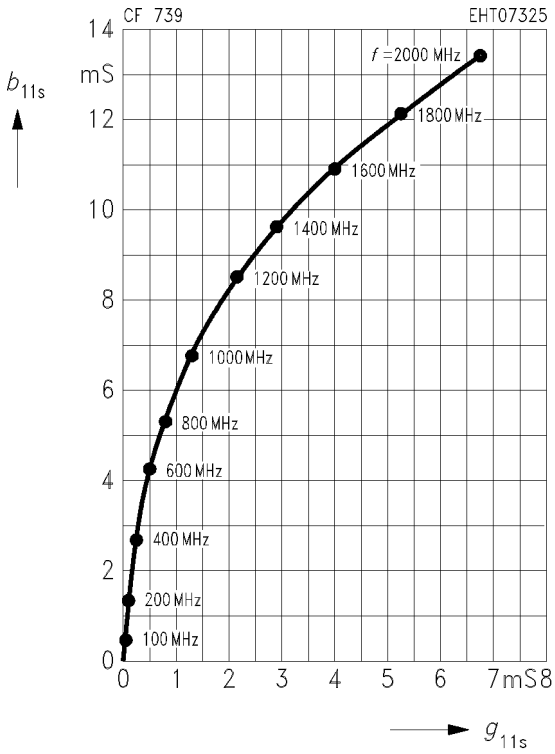

Output admittance y_{22s}

$V_{DS} = 5\text{ V}$, $V_{G2S} = 2\text{ V}$, $I_D = 10\text{ mA}$

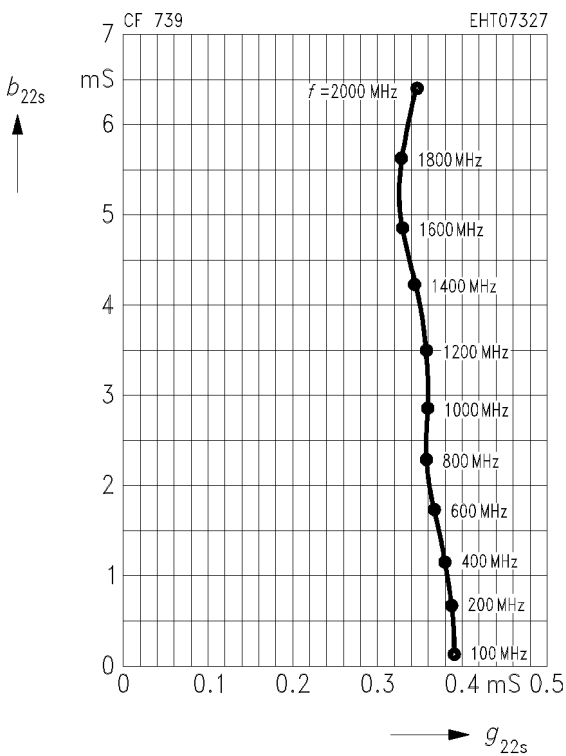

Common Source S-Parameters, G₂ RF grounded

<i>f</i>	<i>S</i> ₁₁		<i>S</i> ₂₁		<i>S</i> ₁₂		<i>S</i> ₂₂	
GHz	MAG	ANG	MAG	ANG	MAG	ANG	MAG	ANG
<i>V</i> _{DS} = 5 V, <i>V</i> _{G2S} = 2 V, <i>I</i> _D = 10 mA, <i>Z</i> ₀ = 50 Ω								
0.06	0.999	– 2.4	3.21	176.9	0.001	81.8	0.963	– 1.0
0.08	0.998	– 3.2	3.21	175.5	0.001	85.8	0.963	– 1.4
0.10	0.998	– 4.1	3.21	174.3	0.001	90.8	0.962	– 1.7
0.15	0.997	– 6.0	3.22	171.4	0.002	84.2	0.962	– 2.5
0.20	0.993	– 8.0	3.22	168.4	0.002	88.1	0.962	– 3.4
0.25	0.989	– 10.1	3.21	165.5	0.003	84.4	0.962	– 4.3
0.30	0.987	– 12.1	3.21	162.5	0.003	83.3	0.962	– 5.2
0.40	0.975	– 16.0	3.18	156.6	0.004	79.6	0.961	– 6.8
0.50	0.965	– 19.9	3.15	150.7	0.005	78.6	0.960	– 8.5
0.60	0.951	– 23.8	3.12	145.0	0.006	78.0	0.960	– 10.3
0.70	0.935	– 27.5	3.09	139.3	0.007	76.6	0.961	– 12.0
0.80	0.918	– 31.4	3.05	134.0	0.008	73.3	0.958	– 13.7
0.90	0.900	– 35.2	3.03	128.5	0.009	70.4	0.956	– 15.4
1.00	0.877	– 39.0	3.02	122.9	0.009	69.5	0.955	– 17.0
1.20	0.883	– 46.6	2.96	111.4	0.010	66.4	0.953	– 20.6
1.40	0.773	– 53.7	2.85	99.7	0.011	59.9	0.949	– 24.3
1.50	0.744	– 56.8	2.77	94.4	0.012	59.9	0.949	– 26.2
1.60	0.720	– 60.1	2.74	89.2	0.012	57.5	0.949	– 27.9
1.80	0.666	– 66.2	2.64	78.9	0.012	54.1	0.948	– 31.5
2.00	0.614	– 72.8	2.59	68.6	0.012	49.2	0.945	– 35.3
2.20	0.556	– 80.3	2.53	57.4	0.012	43.7	0.941	– 39.4
2.40	0.497	– 87.2	2.45	45.6	0.010	39.4	0.937	– 44.4
2.50	0.466	– 90.2	2.38	40.0	0.009	35.2	0.936	– 47.0
2.60	0.449	– 92.8	2.34	34.5	0.008	32.2	0.936	– 49.6
2.80	0.408	– 97.1	2.24	23.6	0.005	25.1	0.937	– 54.6
3.00	0.375	– 101.7	2.17	12.2	0.002	– 25.0	0.934	– 59.1

$S_{11}, S_{22} = f(f), Z\text{-plane}$

$V_{DS} = 5\text{ V}, V_{GS} = 2\text{ V}, I_D = 10\text{ mA}, Z_0 = 50\ \Omega$

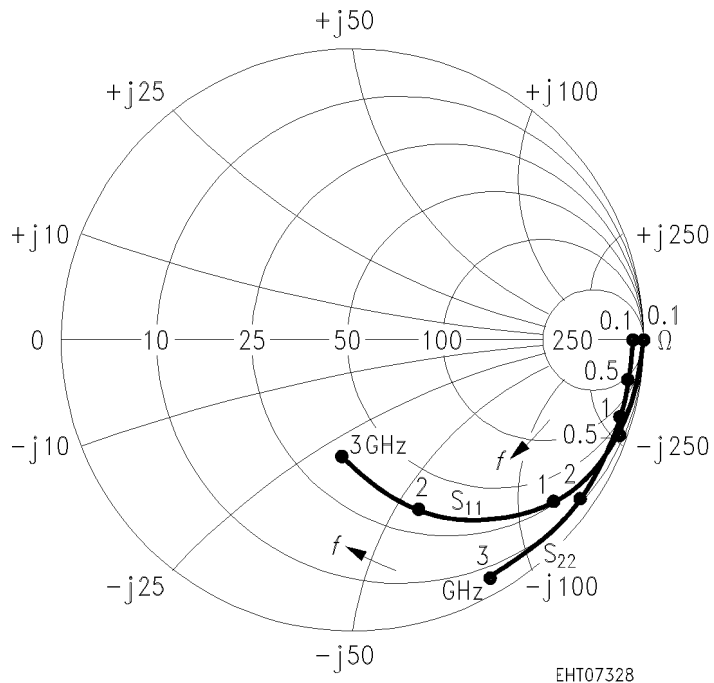

$S_{12}, S_{21} = f(f)$

$V_{DS} = 5\text{ V}, V_{GS} = 2\text{ V}, I_D = 10\text{ mA}, Z_0 = 50\ \Omega$

